

kreon installation manual

technics & dimensions

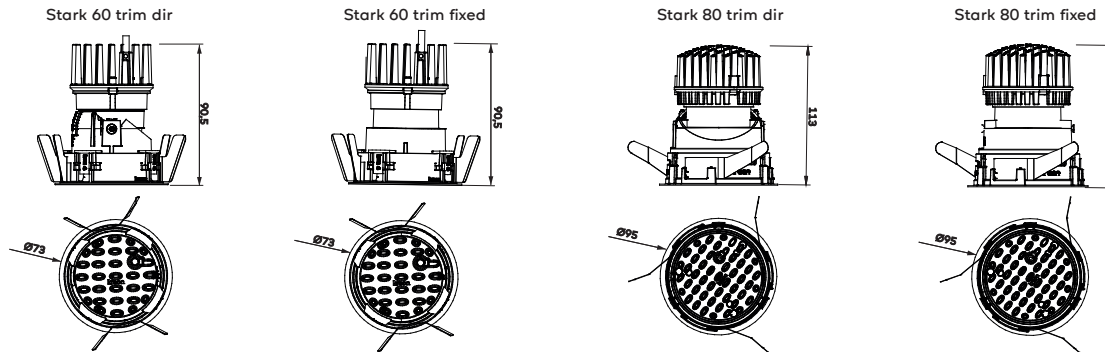

name	reference	current
Stark 60 trim dir/fixed	KR9X7XXX-xxxx-xxx-xx	600mA
Stark 80 trim dir/fixed	KR988XXX-xxxx-(N)SP-xx	600mA
Stark 80 trim dir/fixed	KR988XXX-xxxx-XFL-xx	450mA
Stark 80 trim dir/fixed	KR988XXX-TW-XFL-xx	300mA
Stark 80 trim dir/fixed	KR988XXX-DTW-XFL-xx	400mA

Please make sure the main voltage is disconnected before proceeding! ⚡

1. light source information

The light source contained in this luminaire shall only be replaced by the manufacturer or his service agent or a similar qualified person.

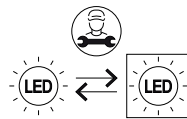

Energy Efficiency Class and EPREL-information for each specific LED/fixture can be found on the last page of this manual

2. installation

electrical diagram

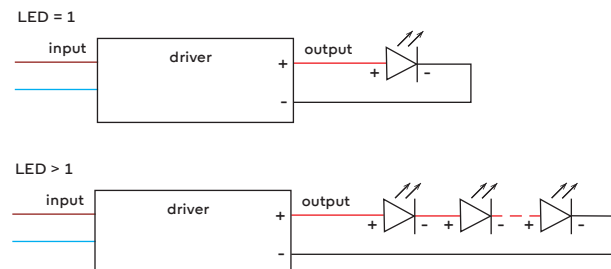

electrical diagram TW

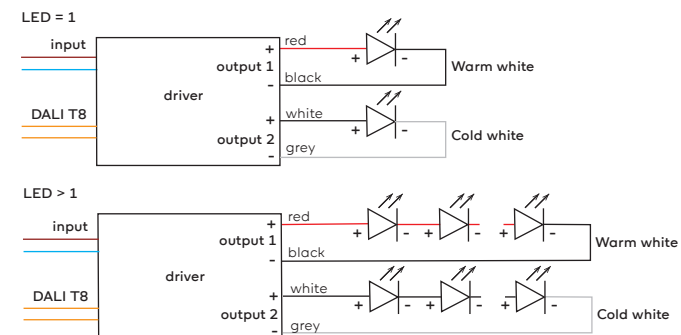

kreon installation manual

3. installation

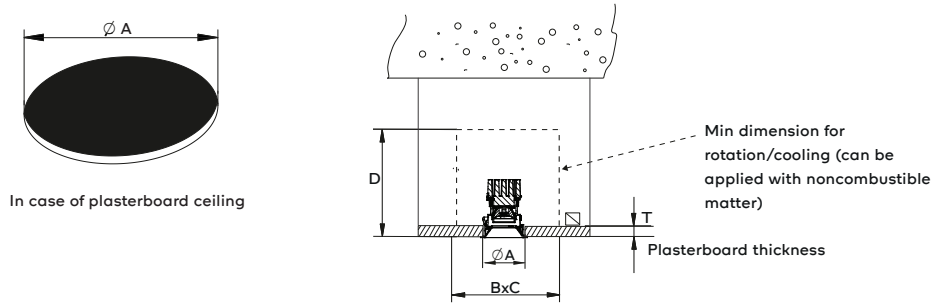

name	reference	A	BxC*	D _{min} *	T _{min} - T _{max}
Stark 60 trim dir	KR9X79XX-xxxX-xxX-xx	Ø68	130x130	100	9-26
Stark 60 trim fixed	KR9X70XX-xxxX-xxX-xx	Ø68	130x130	100	9-26
Stark 80 trim dir	KR9889XX-xxxX-xx-xx	Ø89	130x130	125	9-26
Stark 80 trim fixed	KR9880XX-xxxXxx-xx	Ø89	130x130	125	9-26

*Dimensions may vary depending on the driver used

4. installation

Connect driver

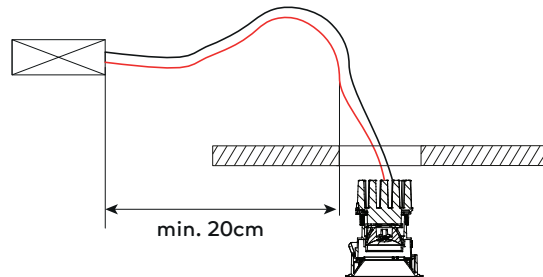

Fold the springs against the ring and and insert into the ceiling.

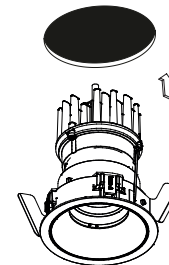

Mind polarity!
+ = red; - = black

In case of TW
Warm white
+ = red; - = black
Cool white
+ = white; - = grey

5. installation

To replace lens/add extra filters

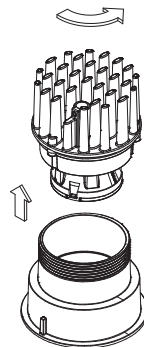

To add extra filters,
unscrew the LED-module.

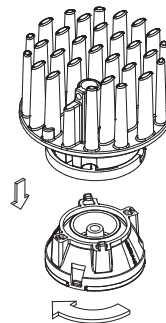

The lens can be replaced
using the bayonet connection.

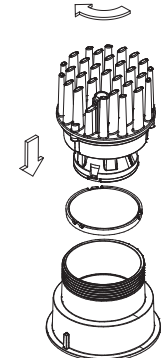
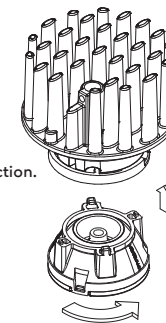

Max. two extra filters
can be added.
Close the module by
screwing.

kreon installation manual

6. installation

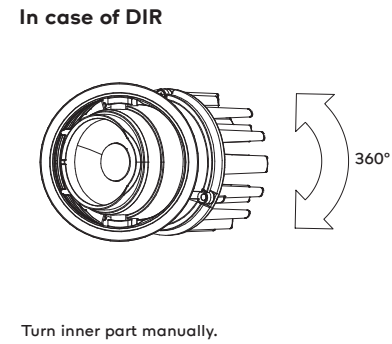
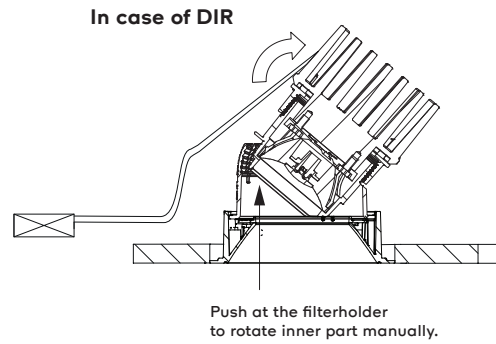



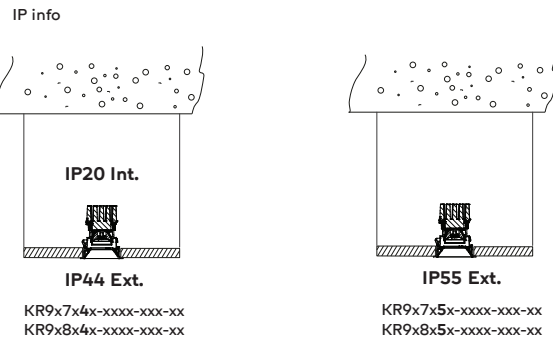



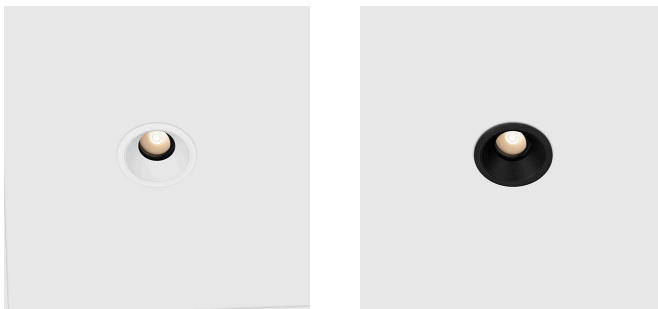



7. installation











8. pictures



kreon light source information

Fixture reference	LED reference	Energy Efficiency Class	QR-code	EPREL link
KR987XXX-9024-NSP-XX KR988XXX-9024-NSP-XX	KR71001003237	E		https://eprel.ec.europa.eu/qr/1569472
KR987XXX-9527-NSP-XX KR988XXX-9527-NSP-XX	KR71001003240	E		https://eprel.ec.europa.eu/qr/1569483
KR987XXX-9530-NSP-XX KR988XXX-9530-NSP-XX	KR71001003241	E		https://eprel.ec.europa.eu/qr/1569487
KR987XXX-9535-NSP-XX KR988XXX-9535-NSP-XX	KR71001003242	E		https://eprel.ec.europa.eu/qr/1569486
KR987XXX-9540-NSP-XX KR988XXX-9540-NSP-XX	KR71001003243	E		https://eprel.ec.europa.eu/qr/1569489
KR987XXX-9024-SP-XX KR987XXX-9024-(x)FL-XX KR988XXX-9024-SP-XX	KR71001003231	D		https://eprel.ec.europa.eu/qr/1569741
KR987XXX-9527-SP-XX KR987XXX-9527-(x)FL-XX KR988XXX-9527-SP-XX	KR71001003232	D		https://eprel.ec.europa.eu/qr/1569755
KR987XXX-9530-SP-XX KR987XXX-9530-(x)FL-XX KR988XXX-9530-SP-XX	KR71001003233	D		https://eprel.ec.europa.eu/qr/1569757
KR987XXX-9535-SP-XX KR987XXX-9535-(x)FL-XX KR988XXX-9535-SP-XX	KR71001003234	D		https://eprel.ec.europa.eu/qr/1569785
KR987XXX-9540-SP-XX KR987XXX-9540-(x)FL-XX KR988XXX-9540-SP-XX	KR71001003235	C		https://eprel.ec.europa.eu/qr/1569783

Fixture reference	LED reference	Energy Efficiency Class	QR-code	EPREL link
KR988XXX-9024-(x)FL-XX	KR71001004519	D		https://eprel.ec.europa.eu/qr/1570085
KR988XXX-9527-(x)FL-XX	KR71001004520	D		https://eprel.ec.europa.eu/qr/1570013
KR988XXX-9530-(x)FL-XX	KR71001004521	D		https://eprel.ec.europa.eu/qr/1570031
KR988XXX-9535-(x)FL-XX	KR71001004522	D		https://eprel.ec.europa.eu/qr/1570028
KR988XXX-9540-(x)FL-XX	KR71001004523	C		https://eprel.ec.europa.eu/qr/1570059
KR988XXX-TW1-(x)FL-XX	KR71001004575	F		https://eprel.ec.europa.eu/qr/876385
KR988XXX-DTW1-(x)FL-XX	KR71001004580	D		https://eprel.ec.europa.eu/qr/2479053
KR987XXX-TW1-(x)FL-XX	KR71001004313	tbd		
KR987XXX-DTW1-(x)FL-XX	KR71001004495	G		https://eprel.ec.europa.eu/qr/2479052

kreon replacement parts

replacement parts

